

PRODUCT DATA SHEET

Burlington[®]



PRODUCT CODE

GU560TMC

RANGE

Guild

DESCRIPTION

Guild Vanity Top 560mm with Upstand
Cararra

CATEGORY	Furniture
WARRANTY DETAILS	10 Years
COLOUR	Cararra
PRIMARY MATERIAL	Solid Surface
INSTALL TYPE	Furniture Mounted
PRODUCT WIDTH MM	522
PRODUCT HEIGHT MM	20
PRODUCT DEPTH MM	492
PRODUCT NET WEIGHT KG	18
STANDARDS	BS EN 14749:2016+A1:2022

TECHNICAL DIMENSIONS

Dimensions in mm unless otherwise specified.

Tolerances (per material type) apply.

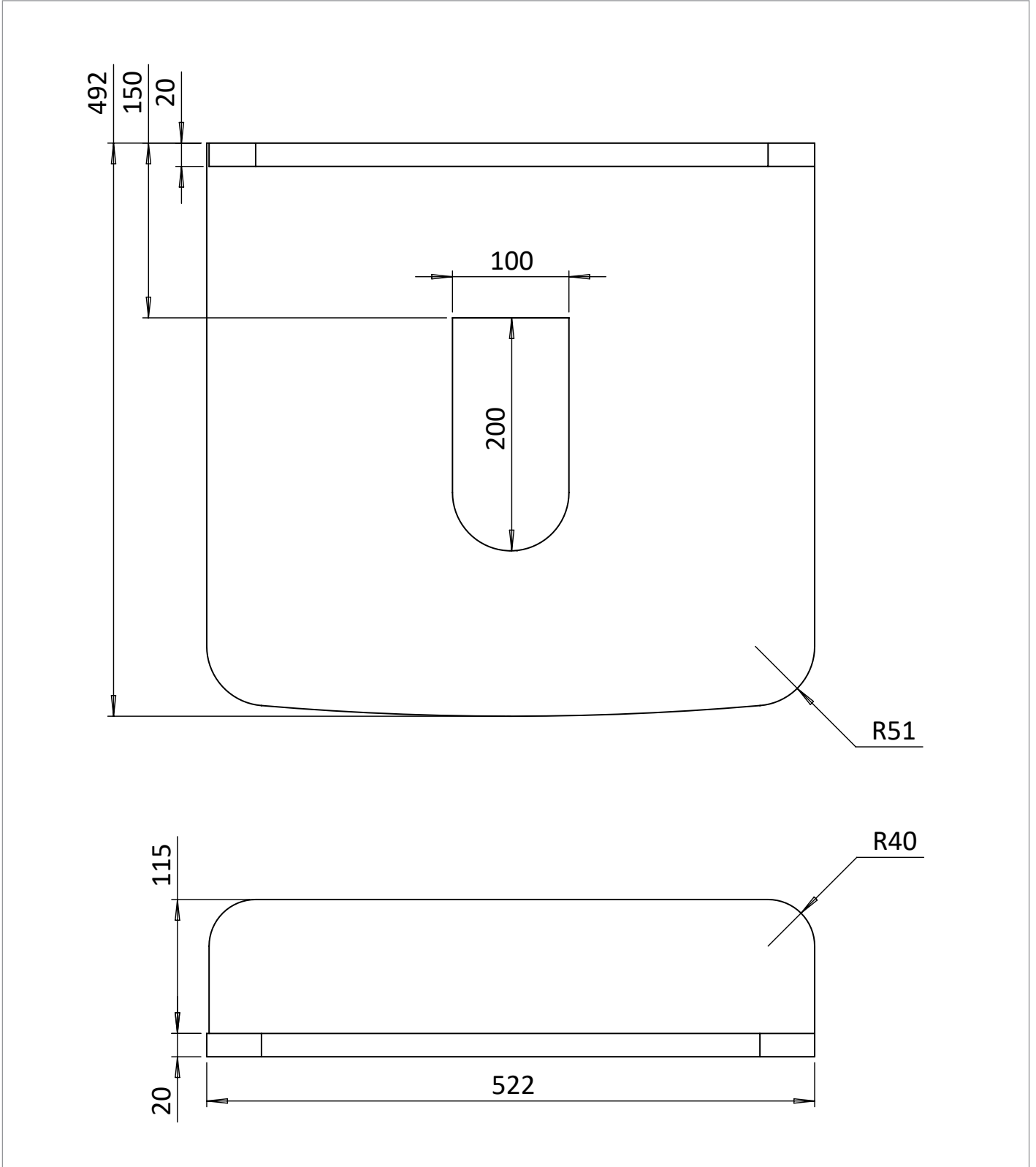

SPARES LIST

Only the parts labelled are available as spares.

NO SPARES AVAILABLE