

PRODUCT DATA SHEET

Burlington[®]



PRODUCT CODE

GU8500DDOK_FS

RANGE

Guild

DESCRIPTION

Guild Floor Standing Vanity 850mm
Dark Oak

CATEGORY	Furniture
WARRANTY DETAILS	10 Years
COLOUR	Dark Oak
FINISH APPLICATION	Veneer
PRIMARY MATERIAL	MDF
SECONDARY MATERIAL	Wood
INSTALL TYPE	Floor Standing
PRODUCT WIDTH MM	780
PRODUCT HEIGHT MM	765
PRODUCT DEPTH MM	522
PRODUCT NET WEIGHT KG	58
STANDARDS	BS EN 14749:2016+A1:2022

DRAWER BOX	MDF
DRAWER RUNNERS	EMUCA - 3120305
DRAWER EXTENSION	Full Extension
DRAWER ADJUSTMENT	2 way adjustment
WALL HANGERS	Yes
ADJUSTABLE FEET	Yes
DRAWER CAPACITY	15 kgs
DRAWER OPERATION	Soft Close

TECHNICAL DIMENSIONS

Dimensions in mm unless otherwise specified.

Tolerances (per material type) apply.

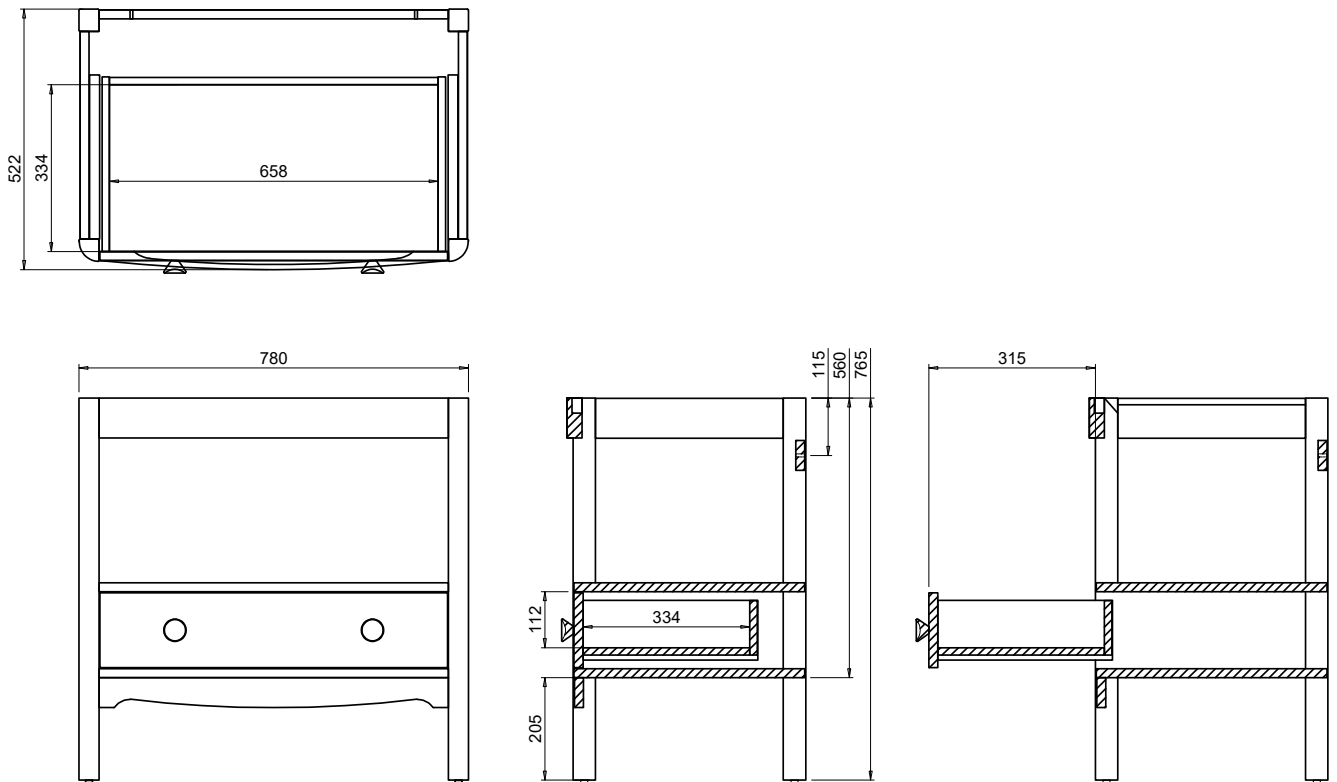

SPARES LIST

Only the parts labelled are available as spares.

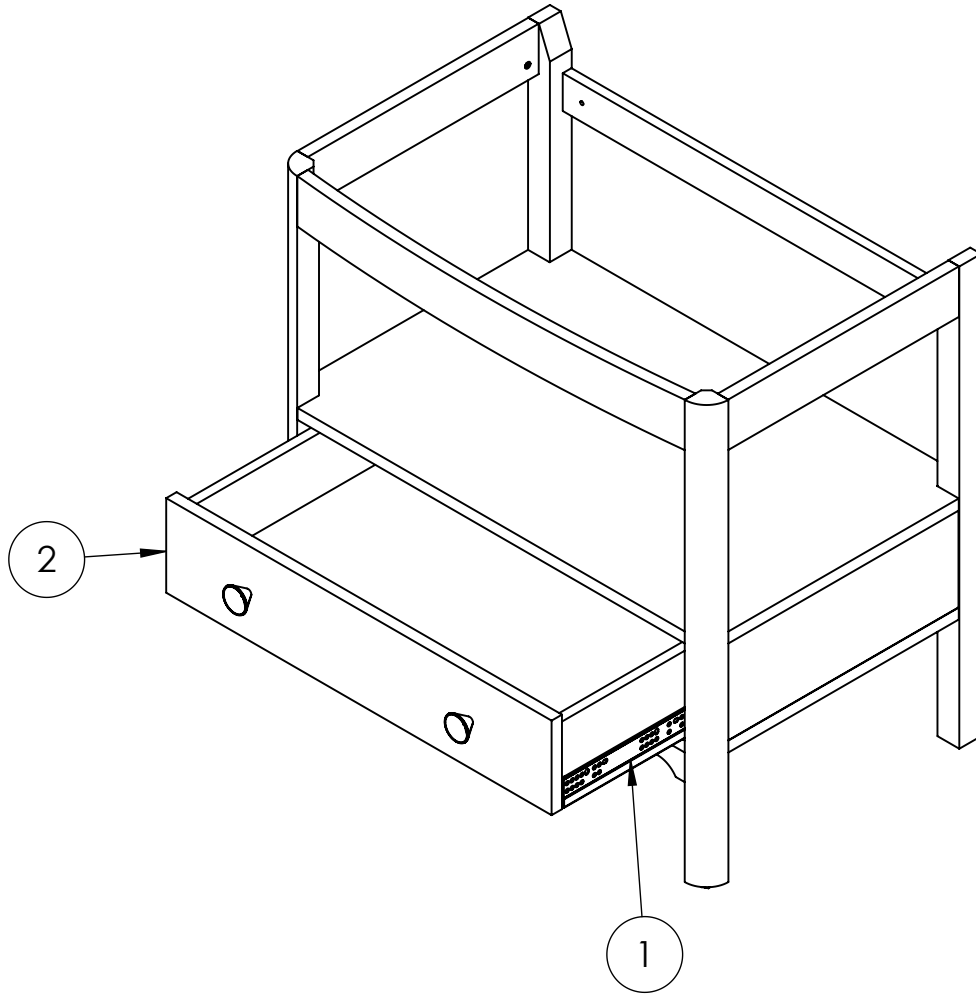

NUMBER	PART CODE	DESCRIPTION
1	RUNNERSGUILD	Guild runners x 1 KIT Left & Right
2	DF_GUI850DLOK	Guild Drawer front only for GU850DLOK_FS
	DF_GUI850DDOK	Guild Drawer front only for GU850DDOK_FS