

# PRODUCT DATA SHEET

*Burlington*<sup>®</sup>



## PRODUCT CODE

GU023C

## RANGE

Guild

## DESCRIPTION

Guild Towel Rail 450 Chrome

CATEGORY	Accessories
WARRANTY DETAILS	15 Years
COLOUR	Chrome
FINISH APPLICATION	Electroplated
PRIMARY MATERIAL	Brass
SECONDARY MATERIAL	Zamac
INSTALL TYPE	Wall Mounted
PRODUCT WIDTH MM	482
PRODUCT HEIGHT MM	70
PRODUCT DEPTH MM	97
PRODUCT NET WEIGHT KG	0.43

## TECHNICAL DIMENSIONS

Dimensions in mm unless otherwise specified.

Tolerances (per material type) apply.

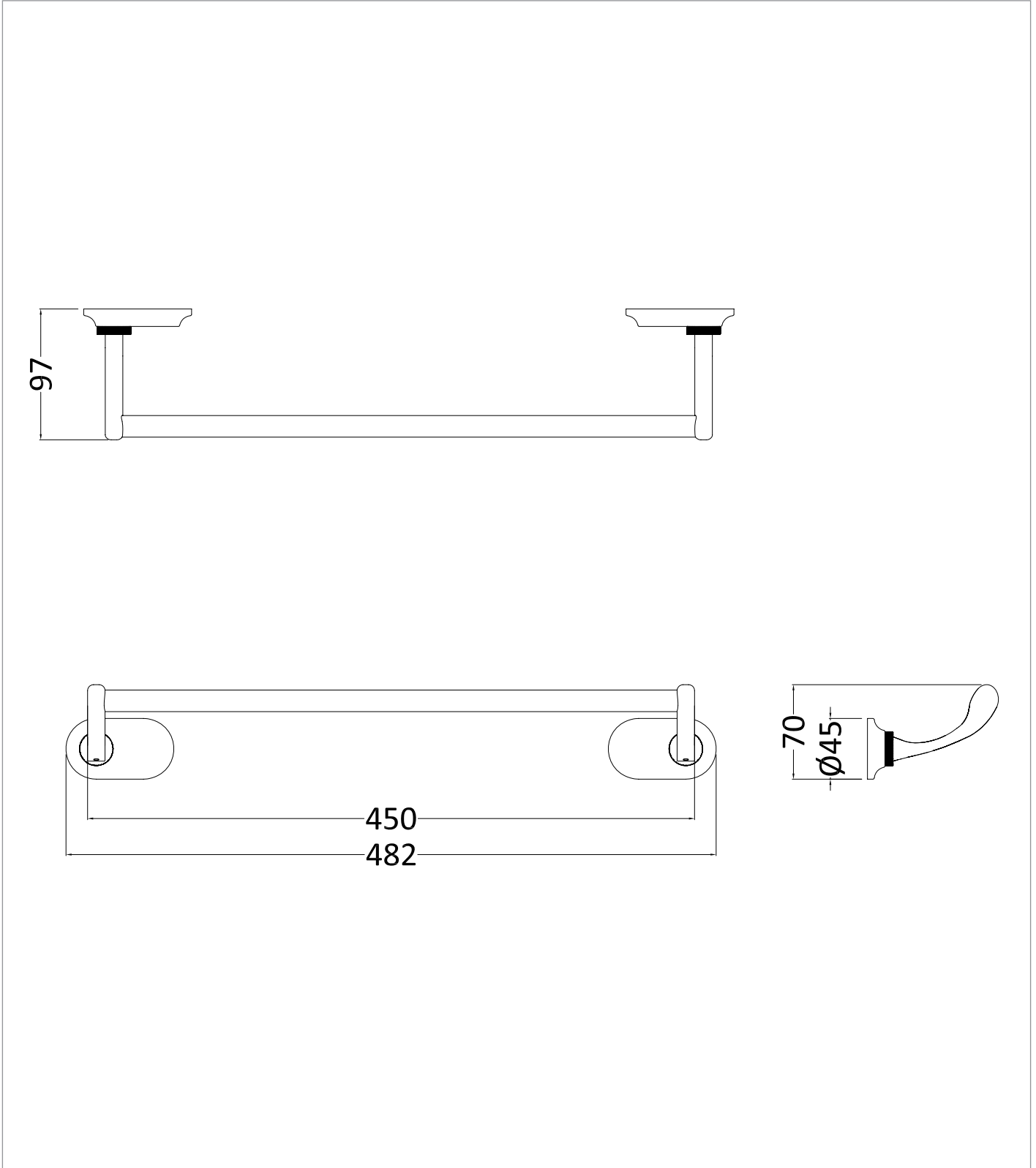

## SPARES LIST

Only the parts labelled are available as spares.

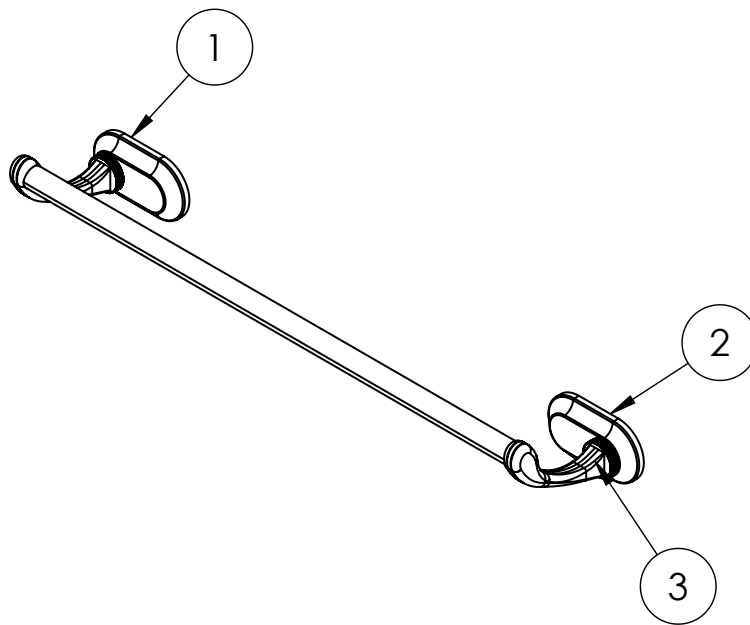

NUMBER	PART CODE	DESCRIPTION
1	SP1814	Guild Screw Bag For GU015, GU023, GU029 And GU030
2	SP1815	Guild Wall Mounting Plate For Accessories
3	SP1816	Guild Grub Screws For Accessories