

PRODUCT DATA SHEET

Burlington[®]

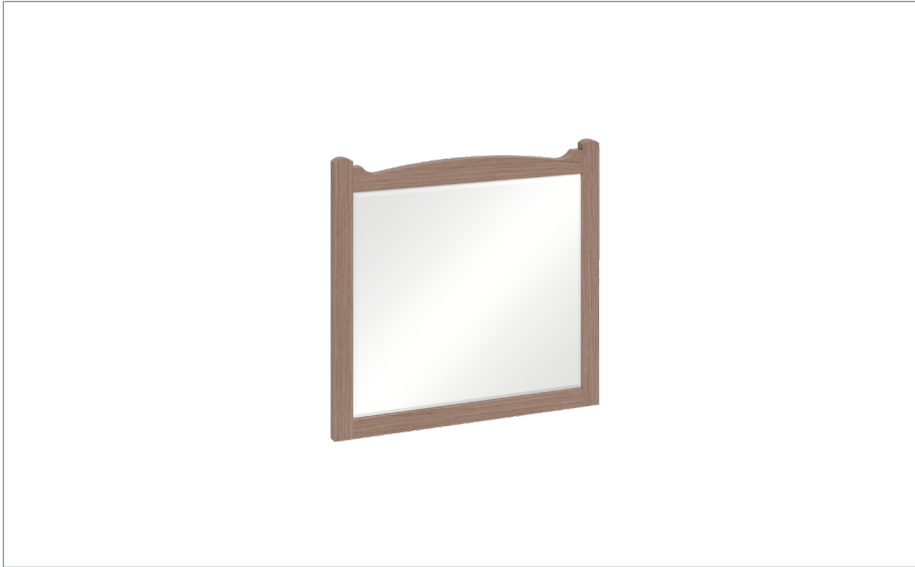

PRODUCT CODE

GU6057DOK

RANGE

Guild

DESCRIPTION

Guild Mirror 600mm Dark Oak

CATEGORY	Cabinets & Mirrors
WARRANTY DETAILS	5 Years
COLOUR	Dark Oak
FINISH APPLICATION	Veneer
PRIMARY MATERIAL	MDF
SECONDARY MATERIAL	Glass
INSTALL TYPE	Wall Mounted
PRODUCT WIDTH MM	600
PRODUCT HEIGHT MM	570
PRODUCT DEPTH MM	25
PRODUCT NET WEIGHT KG	9
STANDARDS	BS EN 14749:2016+A1:2022

NUMBER OF DOORS	0
HANDING MIRROR & CABINETS	Universal
SHELVES ADJUSTABLE	No
SHAVER SOCKET INCLUDED	No
DIMMABLE	No
SHELVE QUANTITY	0

TECHNICAL DIMENSIONS

Dimensions in mm unless otherwise specified.

Tolerances (per material type) apply.

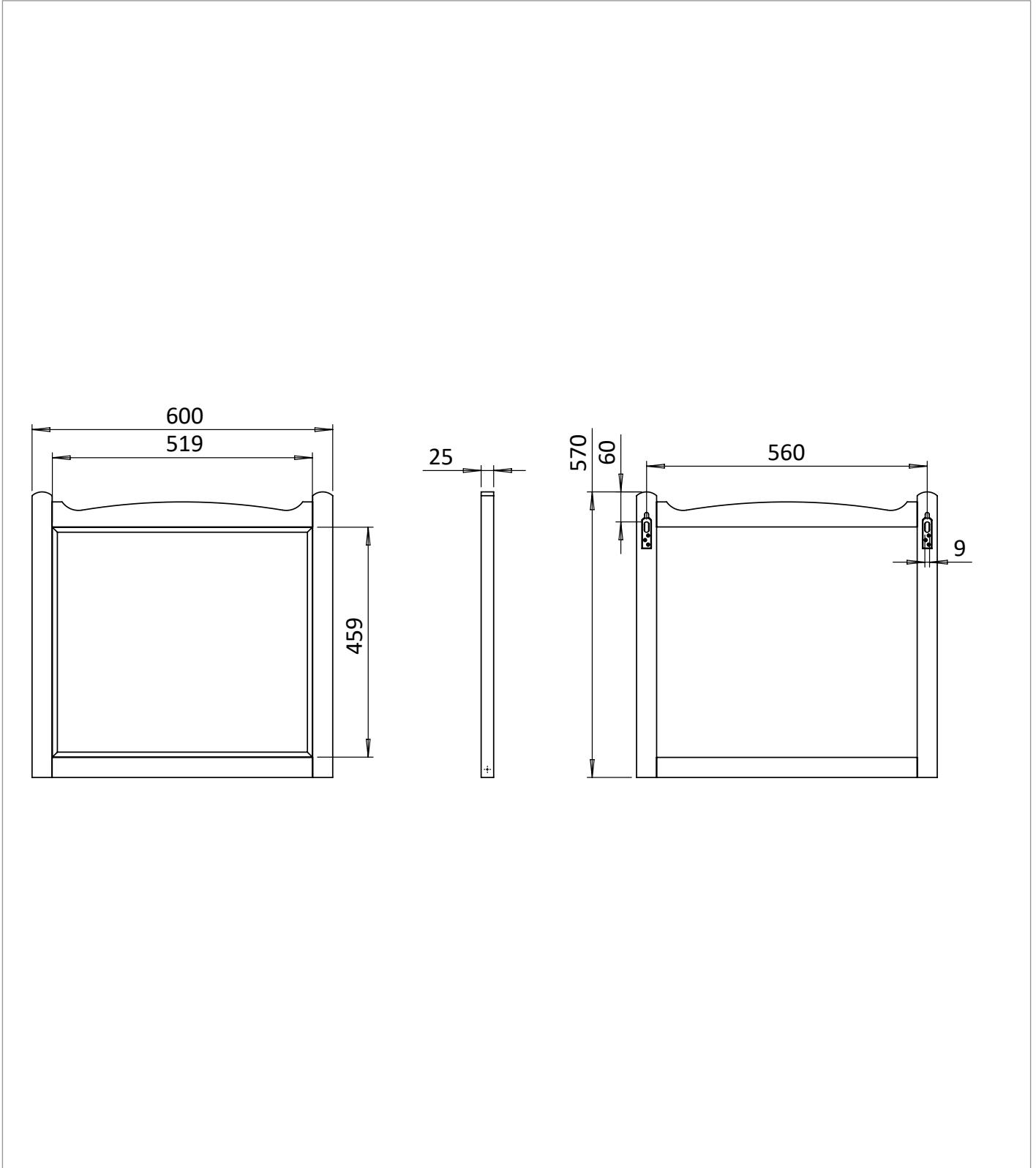

SPARES LIST

Only the parts labelled are available as spares.

SPARES AVAILABLE UPON REQUEST